



Société Nationale de
Certification et d'Homologation
Société à responsabilité limitée









October 14th, 2011

STATEMENT

We confirm, that the following replacement silencer type 5512, produced by SITO Gruppo Industriale S.p.A. (S.G.I.), is complying with

- the EC-Directive 97/24/EC Chapter 9 regarding permissible sound level and exhaust system

An EC type approval number has been granted by the luxembourgian Ministry for Sustainable Development and Infrastructure, department of Transport, for the following version of the above mentioned replacement silencer type:

Silencer Version	Drawing No.	Type approval number	Vehicle type	Vehicle Model
5565	5565	SGI  0497 	C06111 – C025 – ZAPC025 – C25	PIAGGIO ZIP KAT (Air cooled)
5565	5565	SGI  0497 	C44 VAR.1 VERS.00 – ZAP C44100 – ZAP C44200	PIAGGIO FLY 50
5565	5565	SGI  0497 	ZAPC3000 – ZAPC300 – C30 – ZAPC30	GILERA ICE 50 Kat
5565	5565	SGI  0497 	ZD4TH - TH - ZD4SCA - TH Var.G Vers.00	APRILIA SCARABEO 50 STREET



Gilles AST
Expert Technique

Adresse:
BP 23
L-5201 Sandweiler

Siège social:
11, route de Luxembourg
L-5230 Sandweiler

Capital social: 3.500.000 €
R.C. B 27180
N° TVA: LU 13770825

Tél.: (+352) 35 72 14 - 250
Fax: (+352) 35 72 14 - 244
E-mail: info@snch.lu
Home page: www.snch.lu



9932980

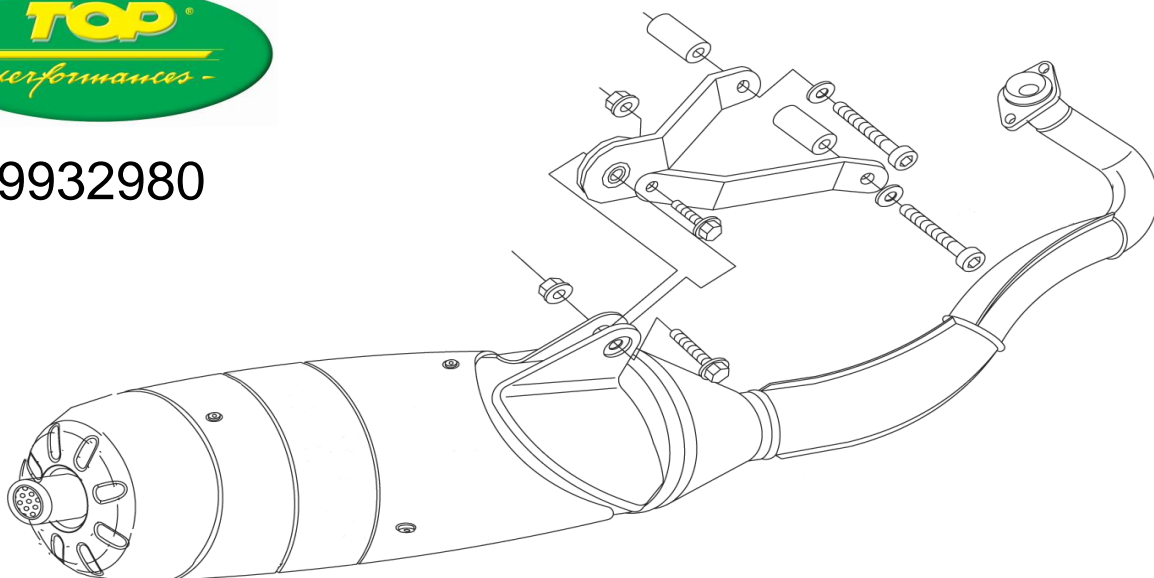

RULLI E MOLLE - ROLLERS AND SPRINGS - MASSELOTES ET RESSORTS - ROLLEN UND FEDERN - RODILLOS Y MUELLES

RULLI: (art. 4659 – gr 6,5 per PIAGGIO ZIP KAT ('00) e Art. 4659 gr. 5,7 per GILERA ICE 50 KAT ('01) e APRILIA SCARABEO 50 STREET air cooled motore Piaggio ('06/'07)- **MOLLE:** (PIAGGIO SOFT BLU).

ROLLERS: (art. 4659 – gr 6,5 for PIAGGIO ZIP KAT ('00) or art. 4659 gr. 5,7 for GILERA ICE 50 KAT ('01), APRILIA SCARABEO 50 STREET air cooled motore Piaggio ('06/'07)) - **SPRINGS:** (PIAGGIO SOFT BLU).

MASSELOTES: (art. 4659 – gr. 6,5 pour PIAGGIO ZIP KAT ('00) et art. 4659 gr. 5,7 pour GILERA ICE 50 KAT ('01), APRILIA SCARABEO 50 STREET air cooled moteur Piaggio ('06/'07)- **RESSORTS:** (PIAGGIO SOFT BLEU).

RODILLOS: (art. 4659 – gr. 6,5 para PIAGGIO ZIP KAT ('00) y art. 4659 gr. 5,7 para GILERA ICE 50 KAT ('01), APRILIA SCARABEO 50 STREET air cooled motor Piaggio ('06/'07)- **MUELLES:** (PIAGGIO SOFT AZUL).

ROLLEN: (art. 4659 – gr 6,5 für PIAGGIO ZIP KAT ('00) und art. 4659 gr. 5,7 für GILERA ICE 50 KAT ('01), APRILIA SCARABEO 50 STREET air cooled motore Piaggio ('06/'07)) - **FEDERN:** (PIAGGIO SOFT BLUE).

**DISEGNO TECNICO RULLI E MOLLE - TECHNICAL DRAWING ROLLERS AND SPRINGS
CROQUIS TECHNIQUE MASSELOTES ET RESSORTS - TECHNISCHE ZEICHNUNG ROLLEN UND FEDERN
DISEÑO TÉCNICO RODILLOS Y MUELLES**

FIGURA 1

- * Battuta rullo
- * Roller beat
- * Retour plastique
- * Anschlag der rolle
- * Batiente de rodillo



FIGURA 2

Senso di rotazione
Clock-wise rotation
Sens de rotation
Drehrichtung
Sentido de rotación

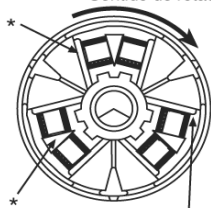

- * Battuta rullo
- * Roller beat
- * Retour plastique
- * Anschlag der rolle
- * Batiente de rodillo

**MOLLE DA SOSTITUIRE - SPRINGS TO BE REPLACED
RESSORTS À REMPLACER - ZU ERSETZENDE FEDER
MUELLES PARA SUSTITUCIÓN**

FIGURA 3

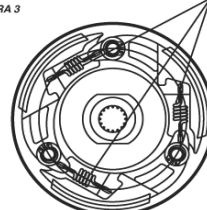

Frizione a 3 molle
3 springs clutch
Embrajage à 3 molle
3-feder-kupplung
Friccion con 3 muelles

FIGURA 4

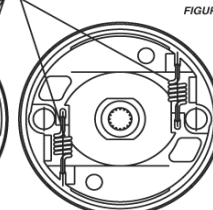

Frizione a 2 molle
2 springs clutch
Embrajage à 2 ressorts
2-feder-kupplung
Friccion con 2 muelles

VISTA DAL LATO INTERNO - VIEW FROM THE INNER SIDE
VUE DE L'INTERIEUR - ANSICHT VON INNENSEITE
VISTA DESDE EL LADO INTERIOR